

# ANEXO 2

## Estampas

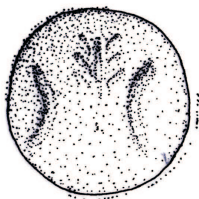
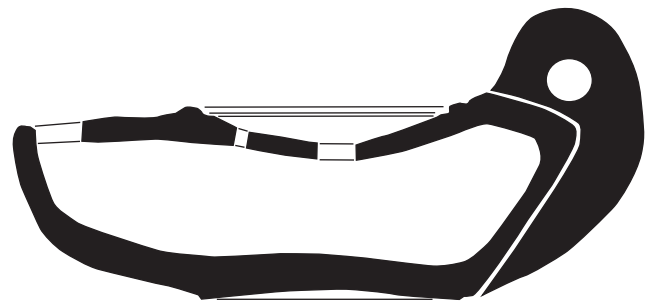
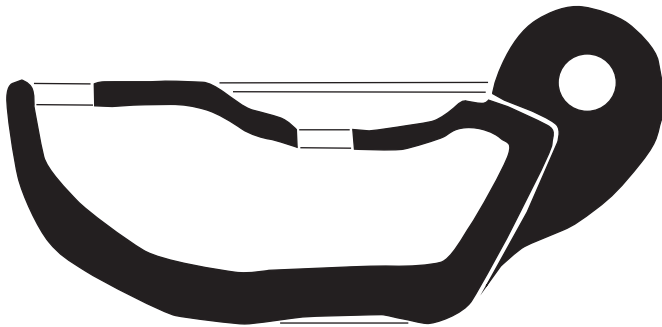
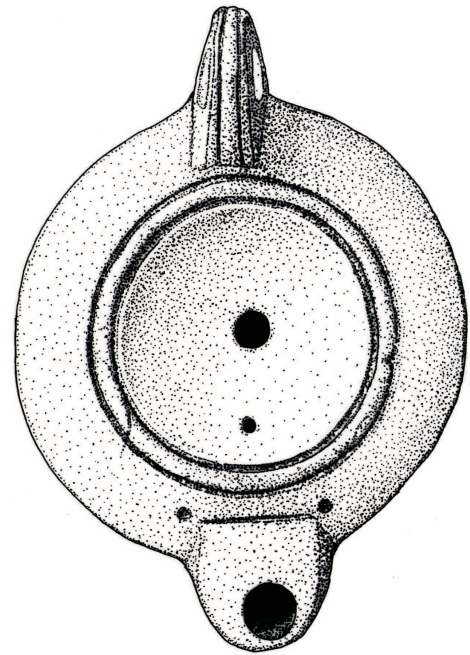
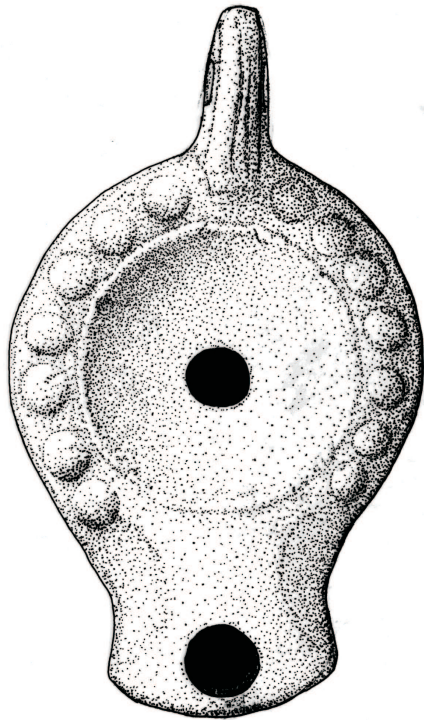

1

2



Estampa I : Lucernas da Necrópole Noroeste da Praça da Figueira recuperadas da intervenção de 1999/2001 - Tipo Rio-Tinto Aljustrel (1) de produção Hispânica, Dressel-Lamboglia 20 (2) de produção itálica.

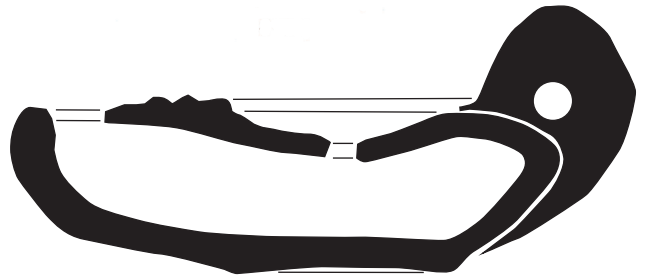
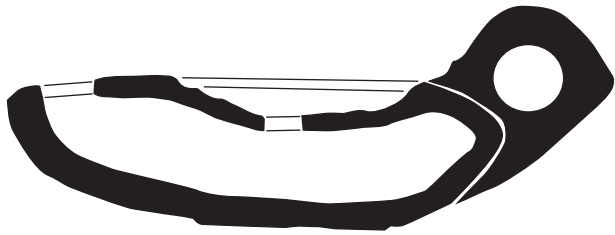
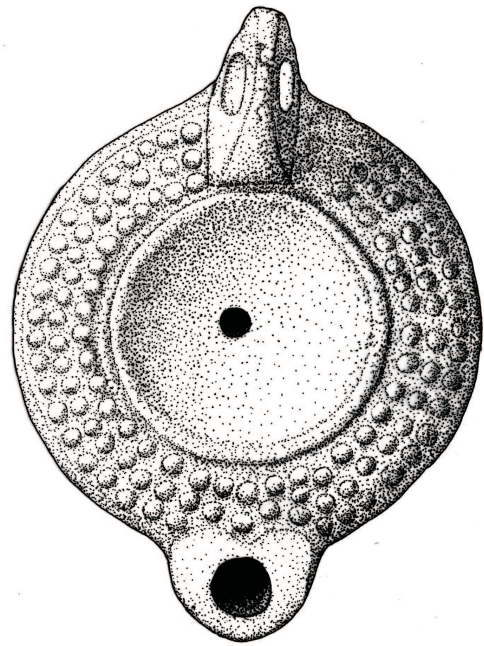
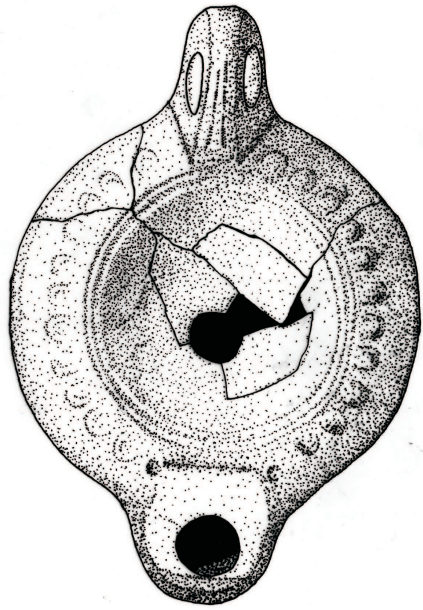

4

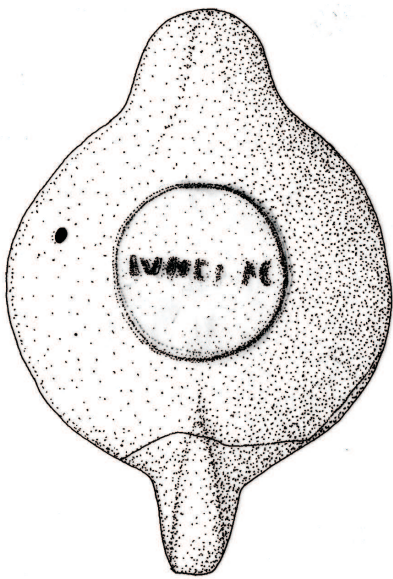

3

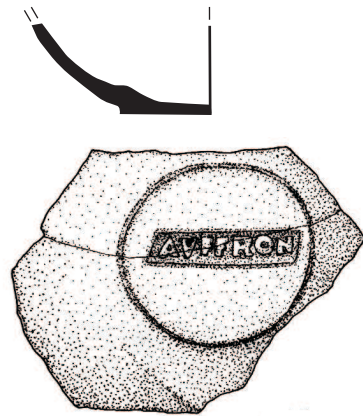

5



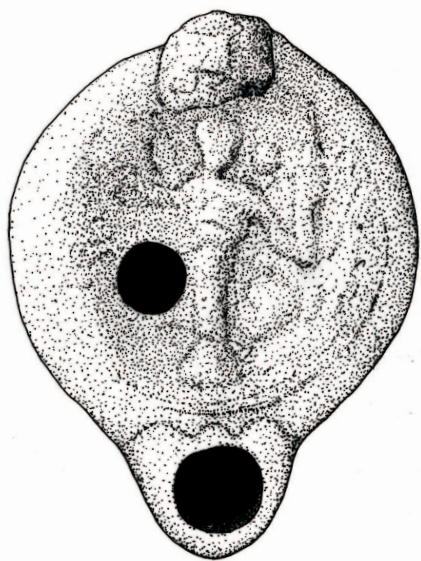

6

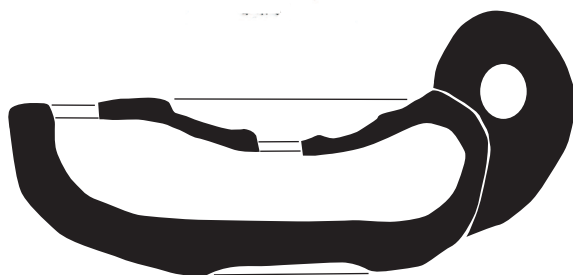
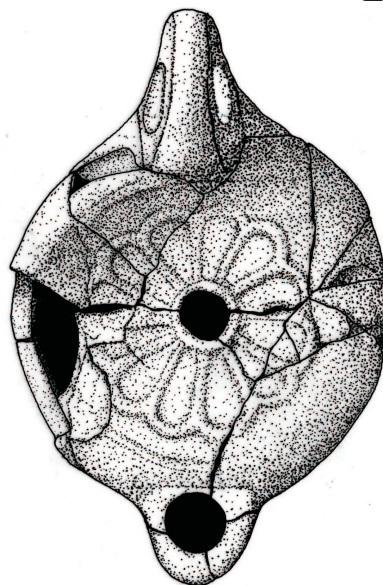

8



7

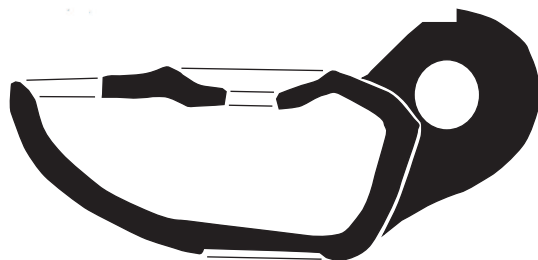
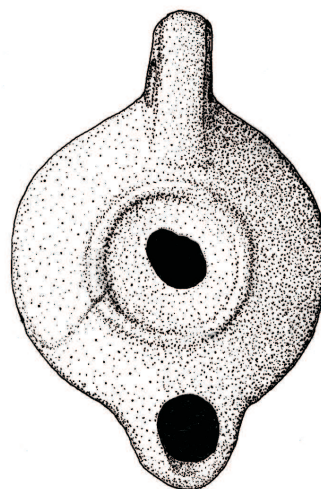

9



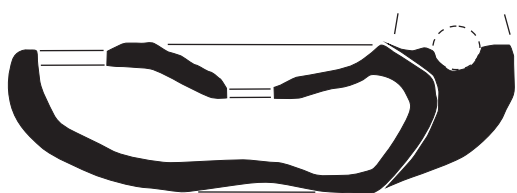
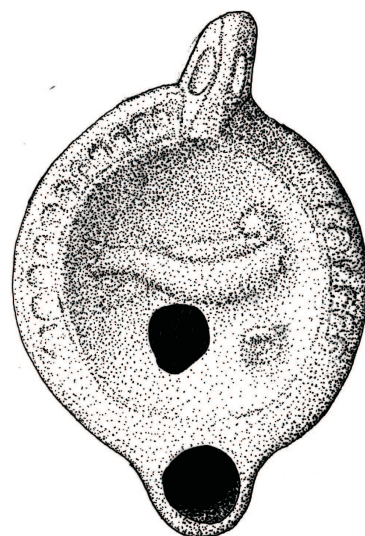
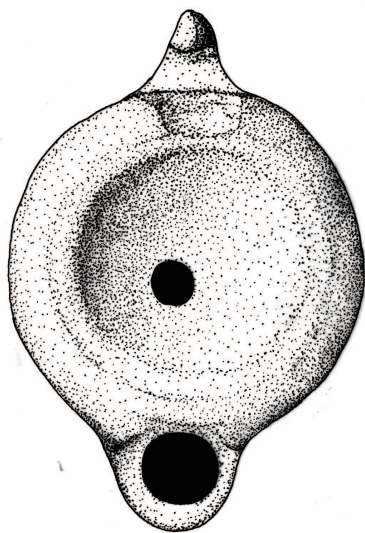

10

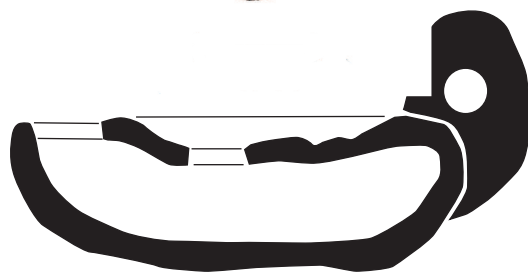

12

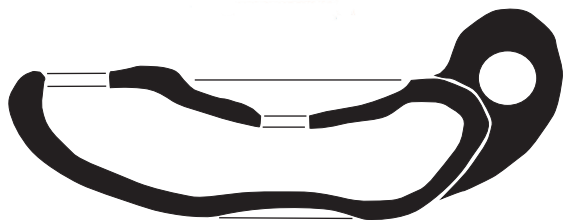
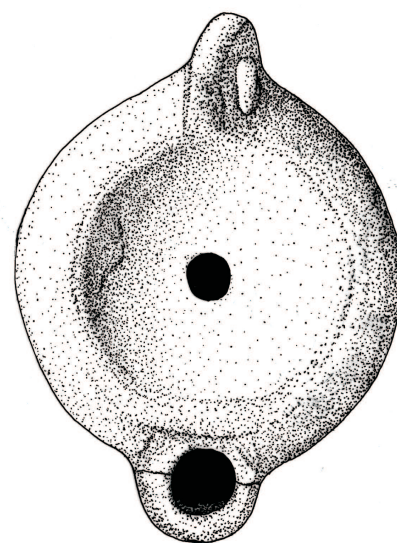
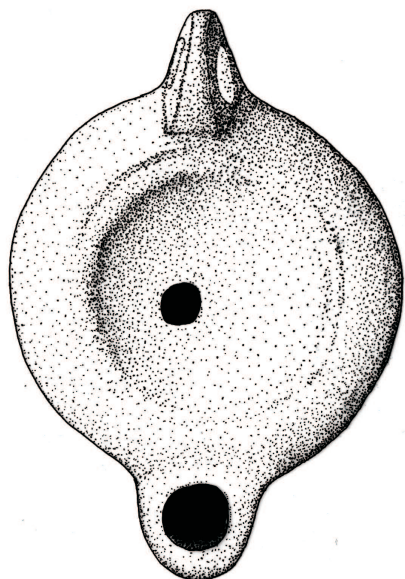

11

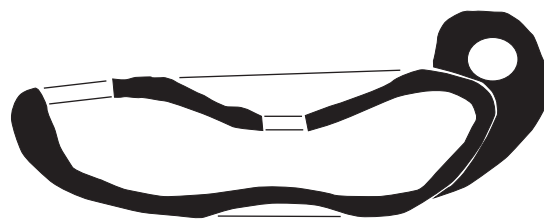

13



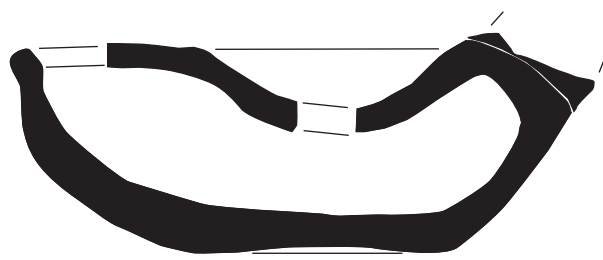
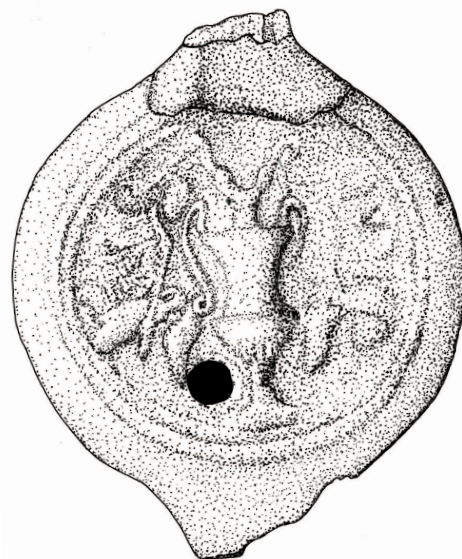
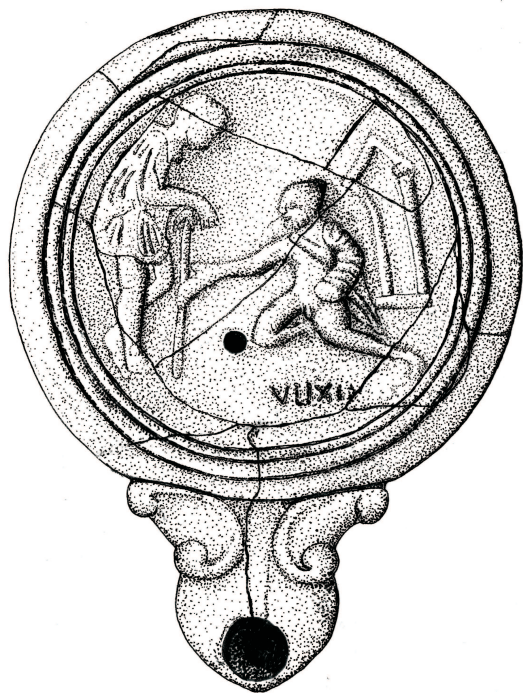

15

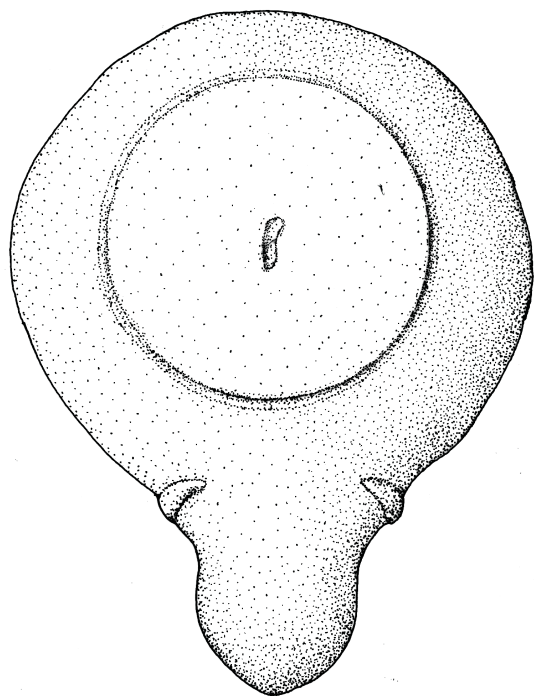

14



Estampa V : Lucernas da Necrópole Noroeste da Praça da Figueira recuperadas da intervenção de 1962 - Dressel-Lamboglia 11 de produção itálica (14) e Dressel-Lamboglia 27/28(?) de produção Hispânica (15)

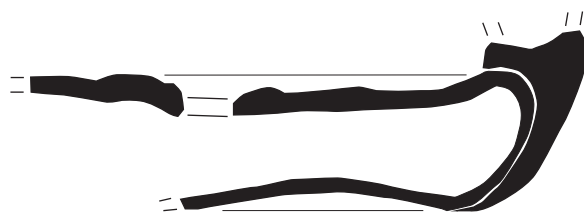
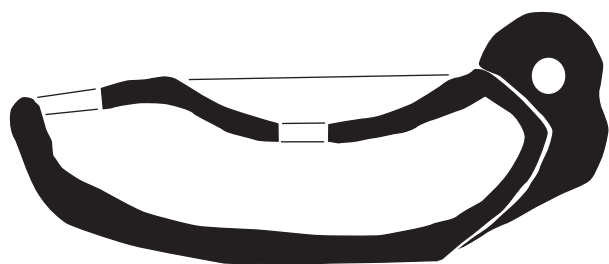
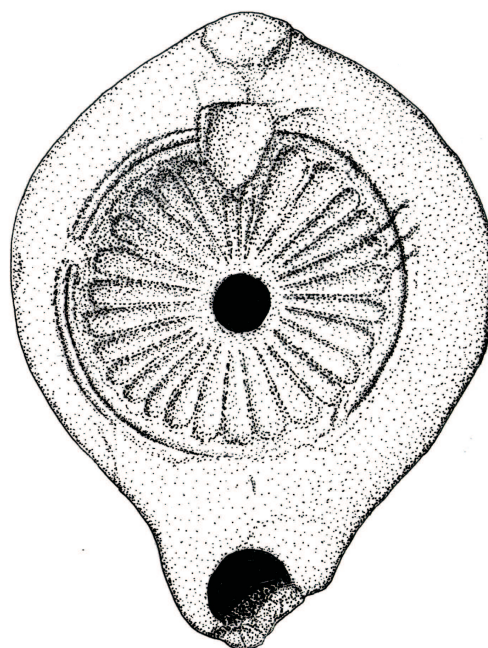
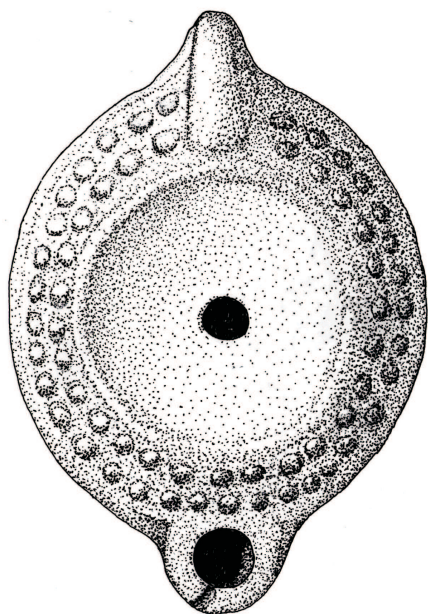

16

17



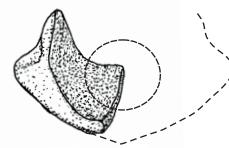

21

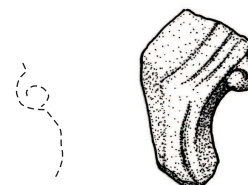

22



18

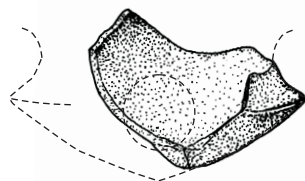

19

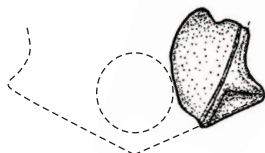

20

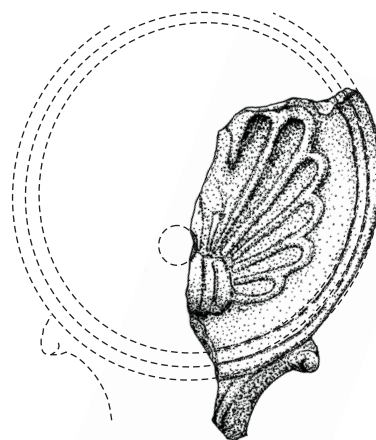

23



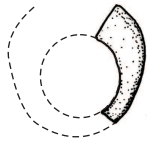

24

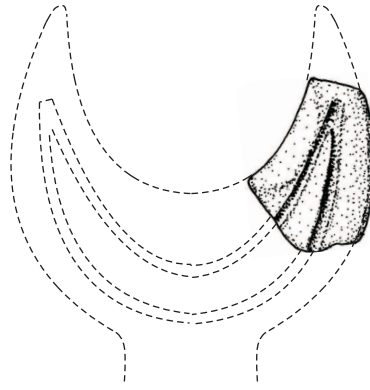

27

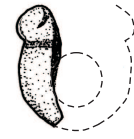

30

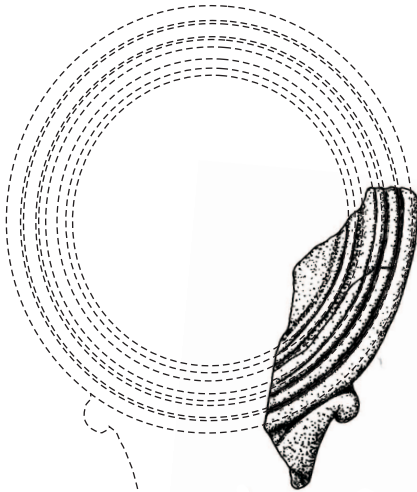

25

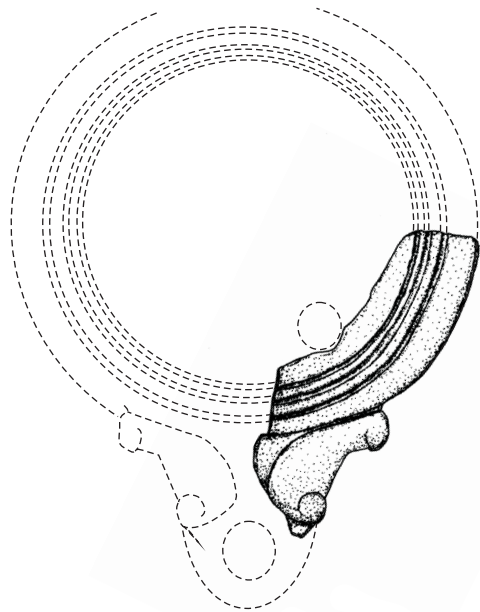

28

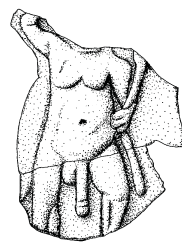

29

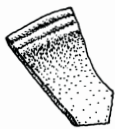

26

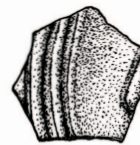

31

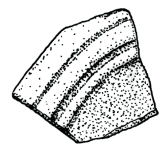

32



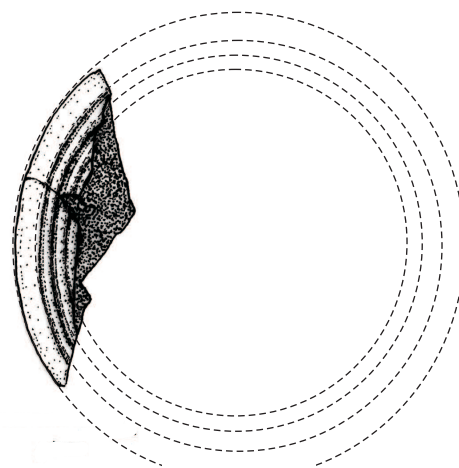
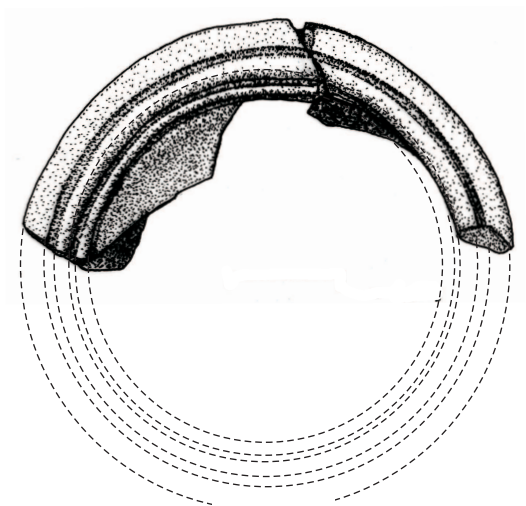

33

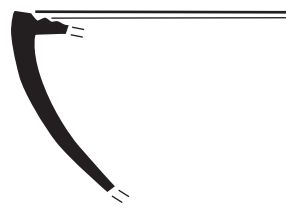

35

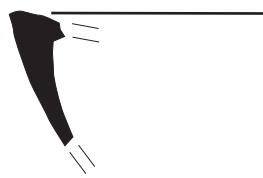
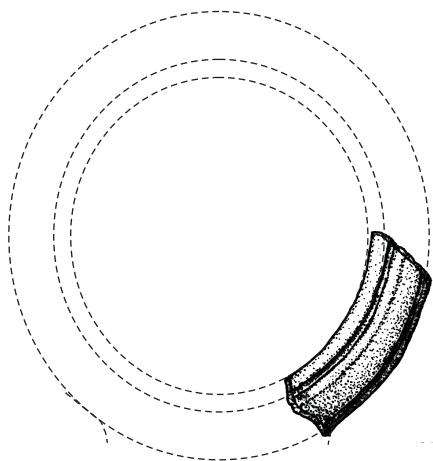

36

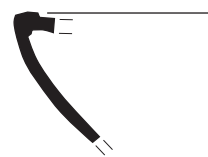

38



34

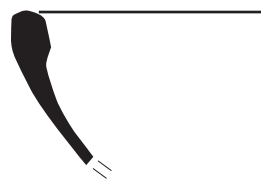

37

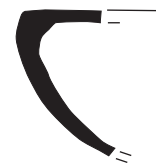

39



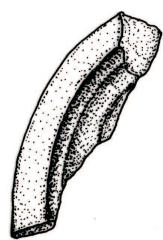

40

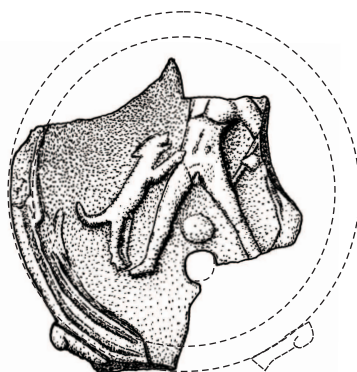

42



45

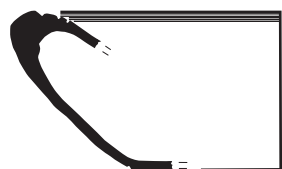
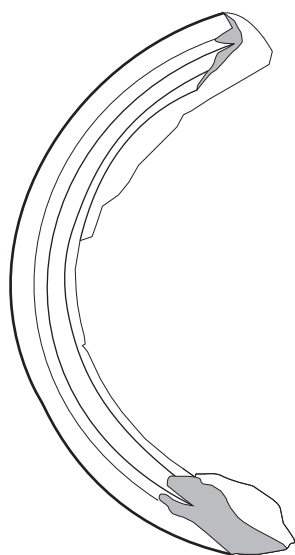

41



43



46

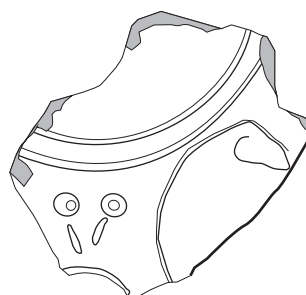

44



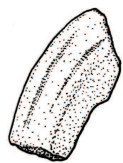

47

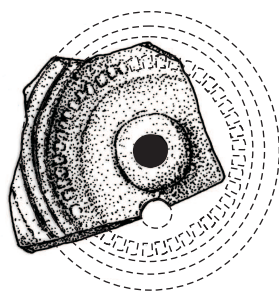

50

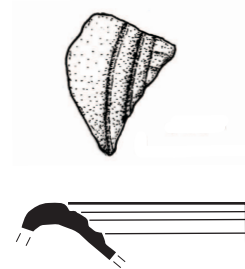

54



48



51



55

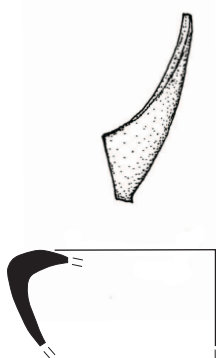

49



52



56



53





57



61



65



67

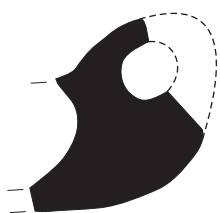

58



62



68



59



63



69

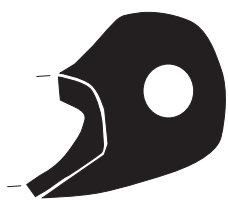

60



64



66

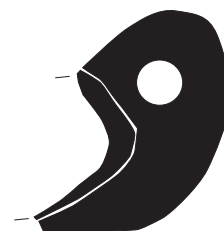

70



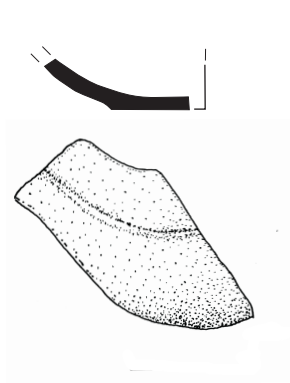

71

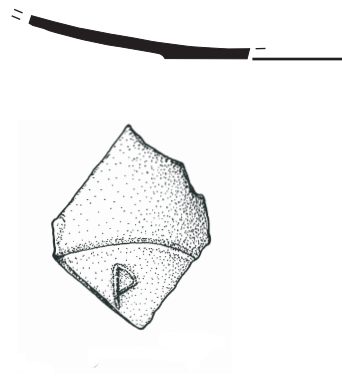

75

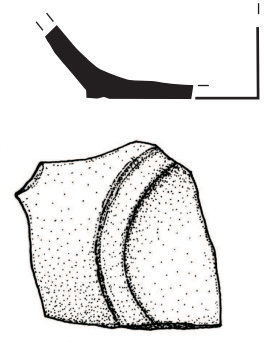

78

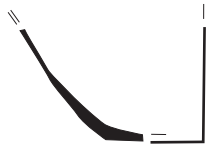

72



76

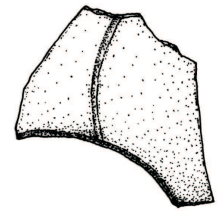

79



73

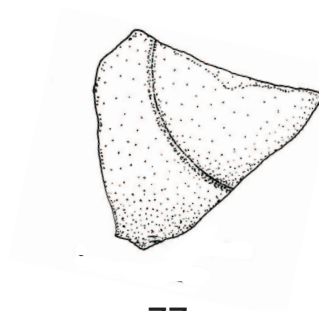

77



74



80



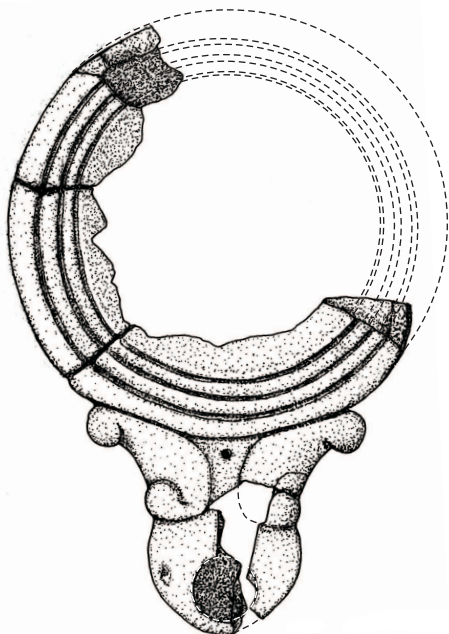

81

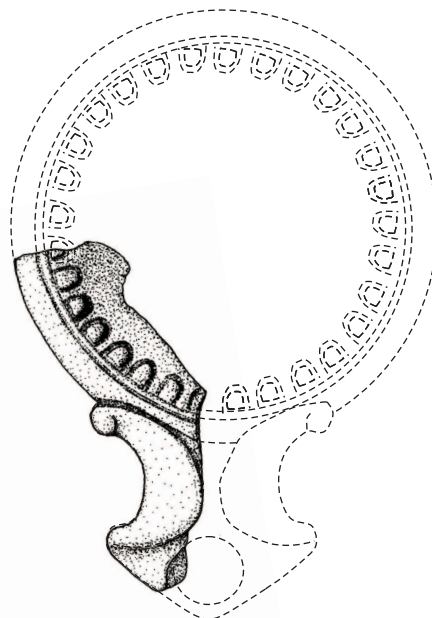

83

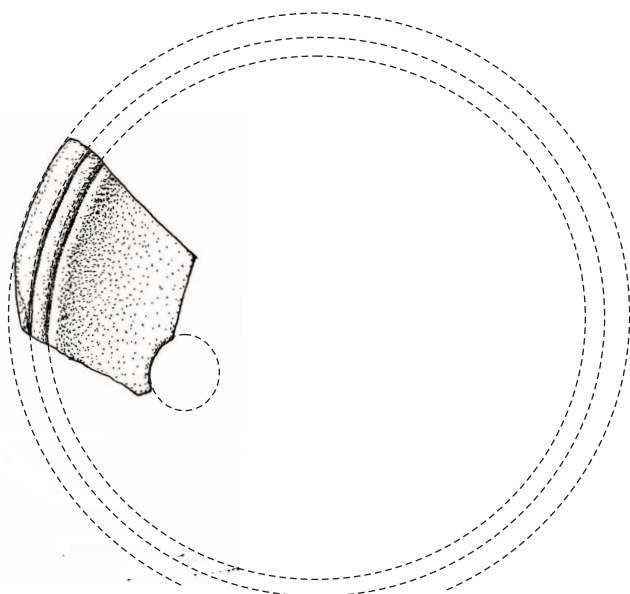

82



84

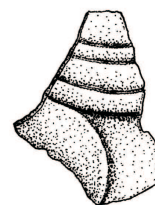

86



85

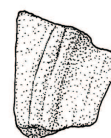

87



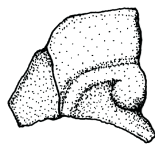
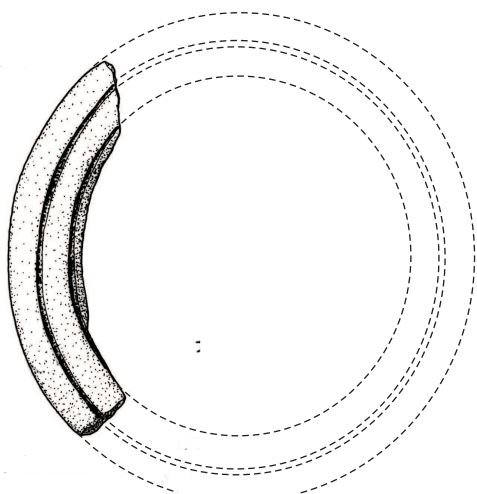

91



95



98

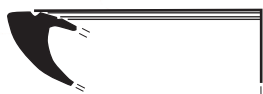

88

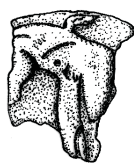

92



96

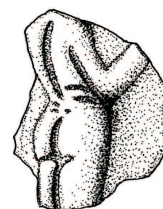

99

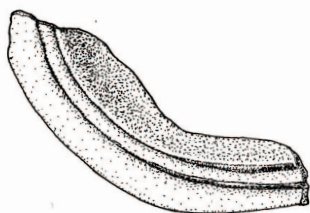

89

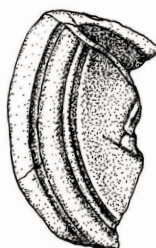

93



100



90

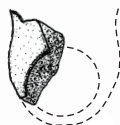

94

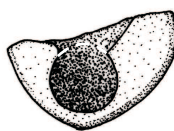

97

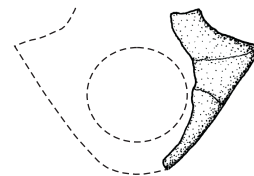

101



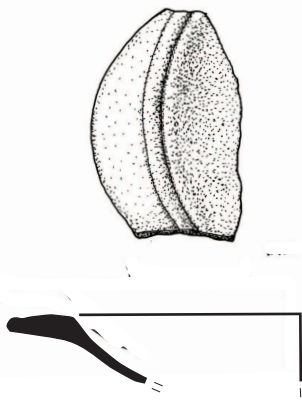

102

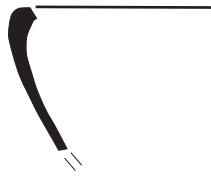

105

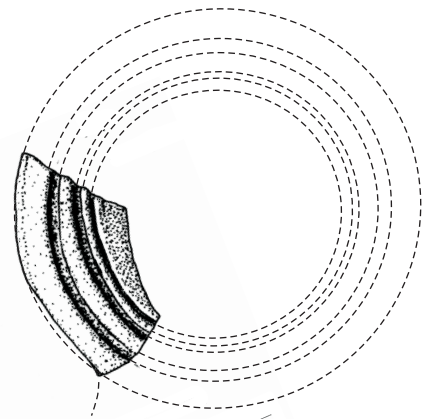

108

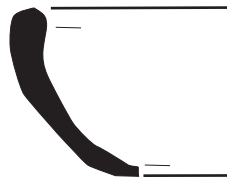

106

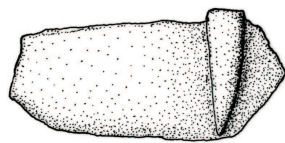

103

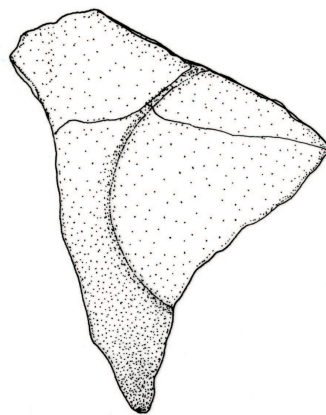

107



109



104



110

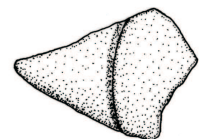

111



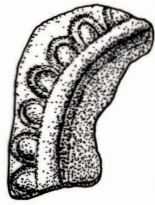

112



116

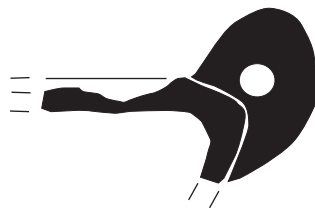

114

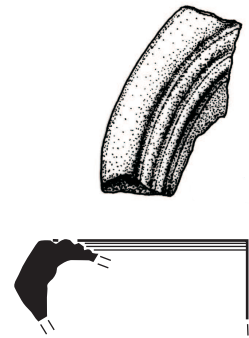
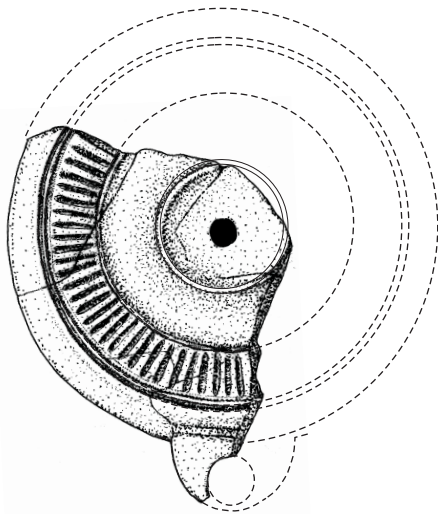

117

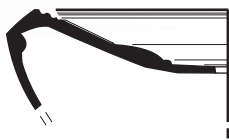

113

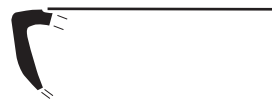

115



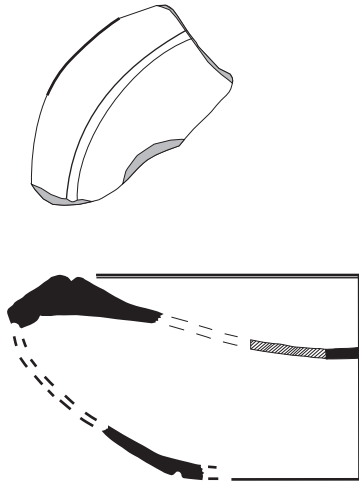

118

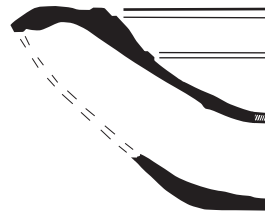
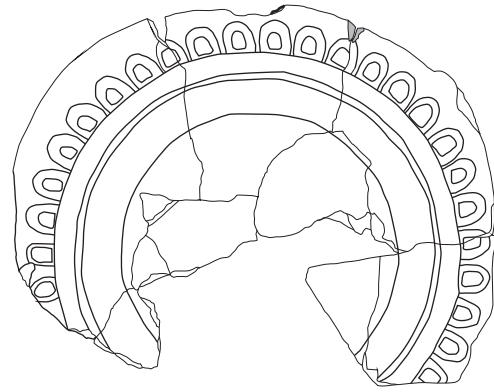

120

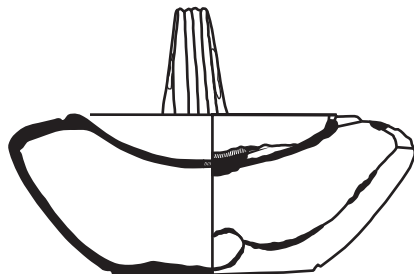
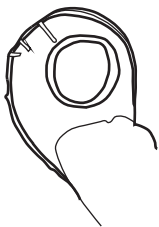
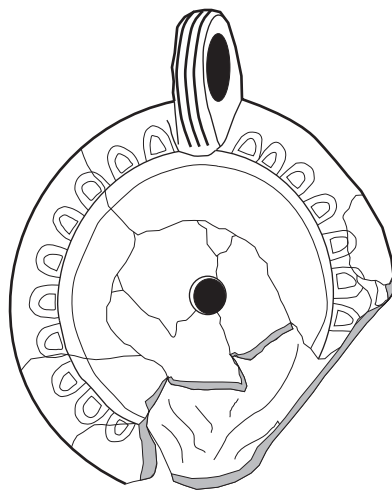

119

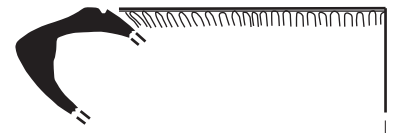
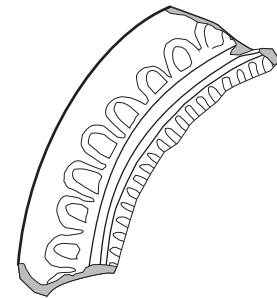

121



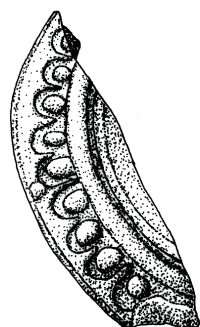

122



124

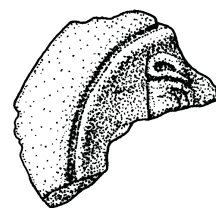

127



125

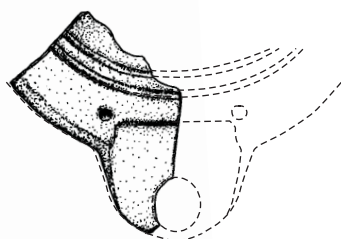

123

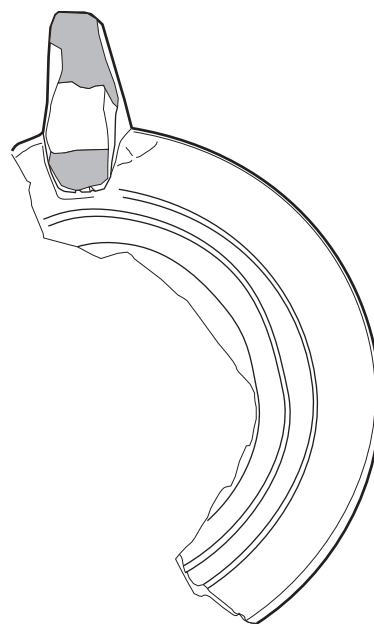

126



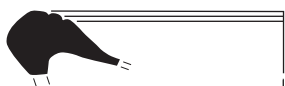
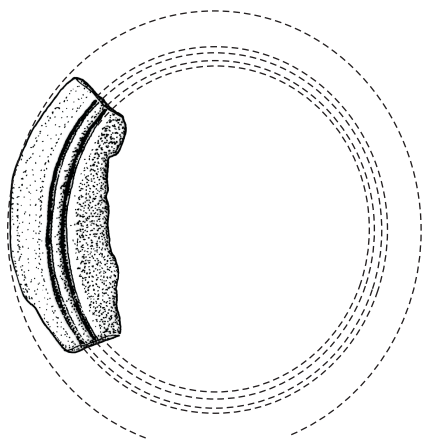

128

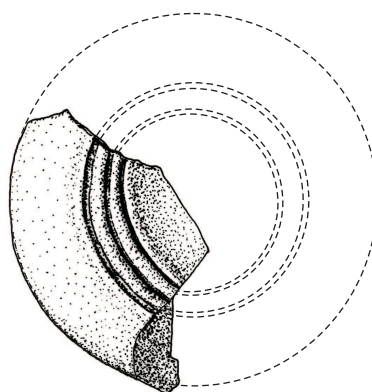

129

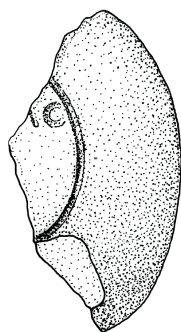
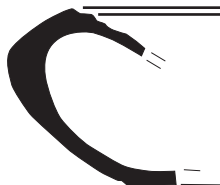
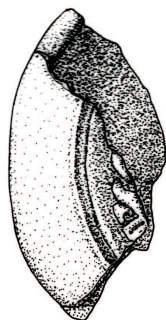

130



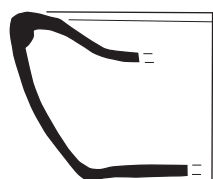
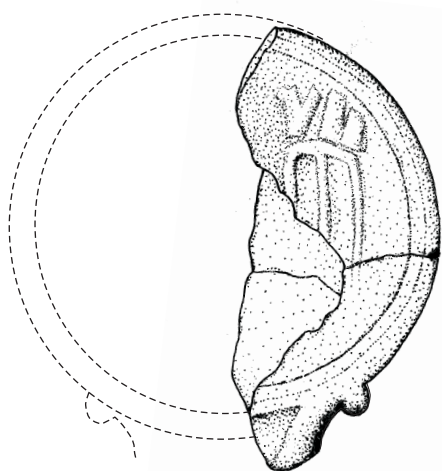

131



133

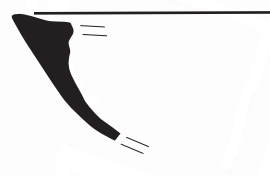
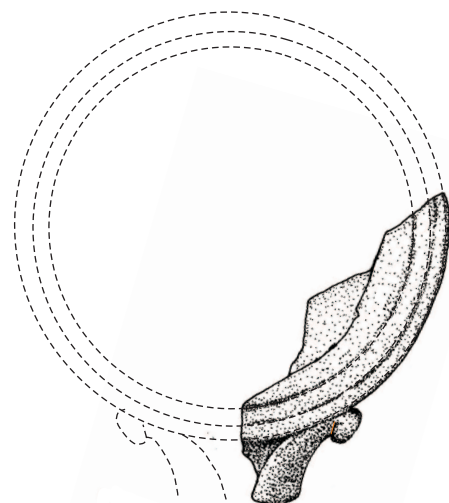

135

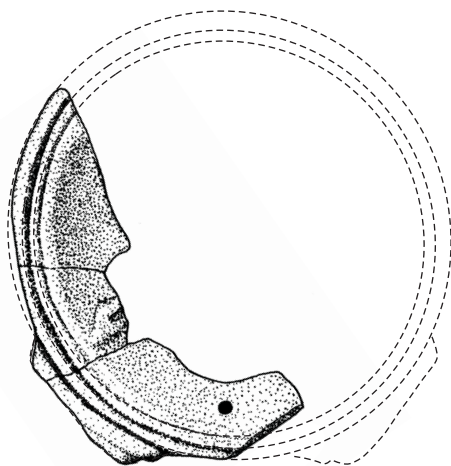

132

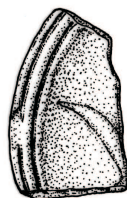

134

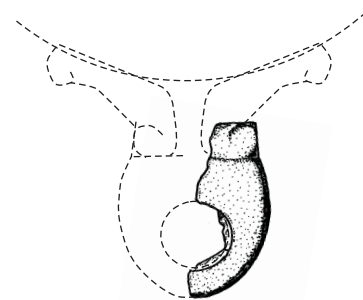

136



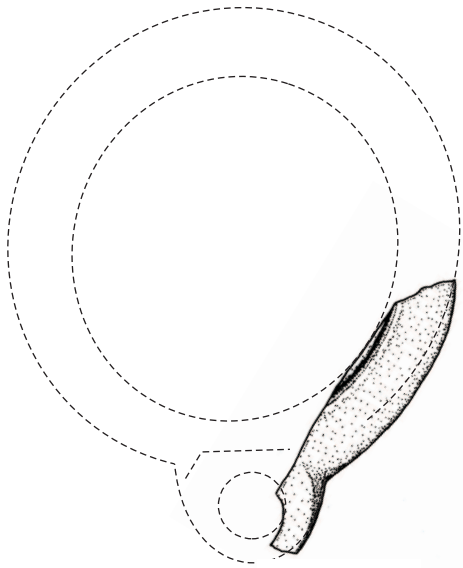

137

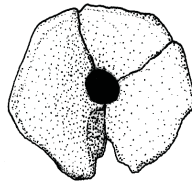

140



141

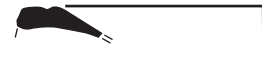
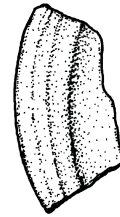

142

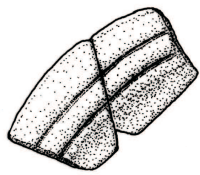

138

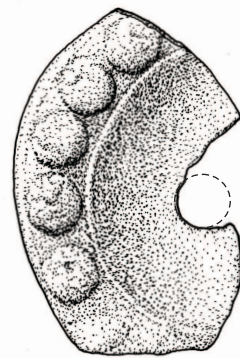

139

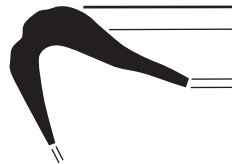

143



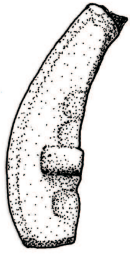

148



151



144



149



145



152



146

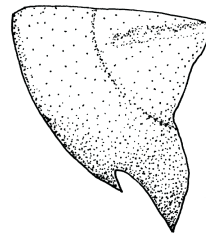

150



147



153



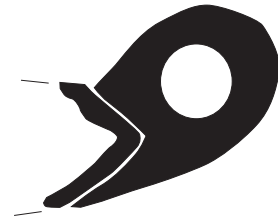
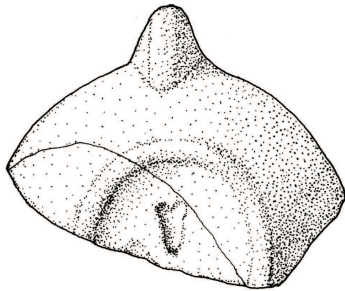
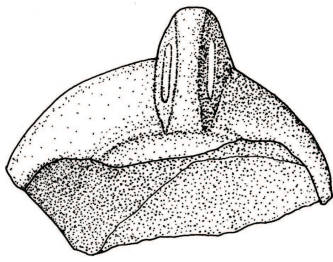

155



154

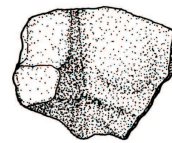

156



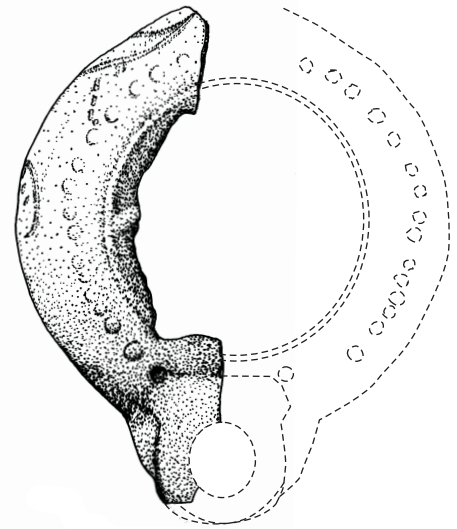
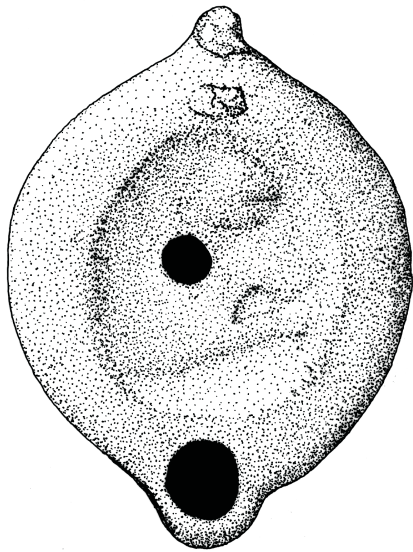

160

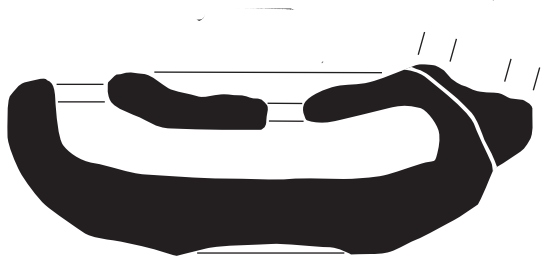

157

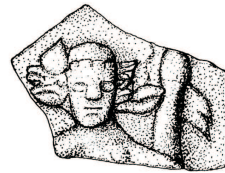

161

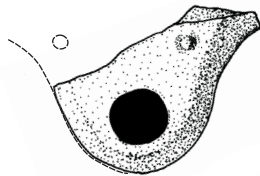

158

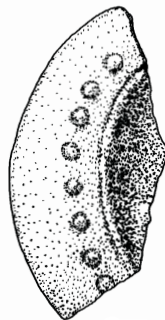

162

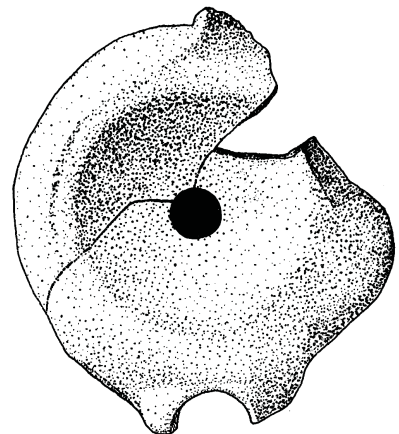

163

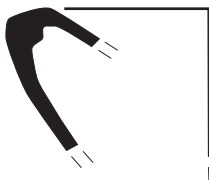

159



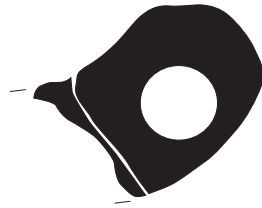
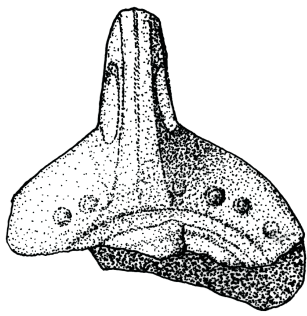

167



171

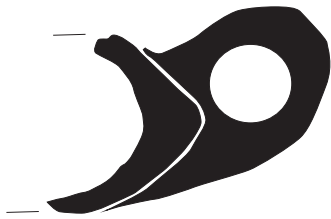

164



168



172



165

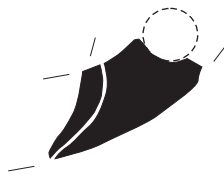

169

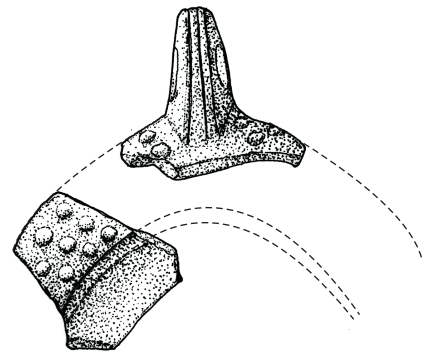

166

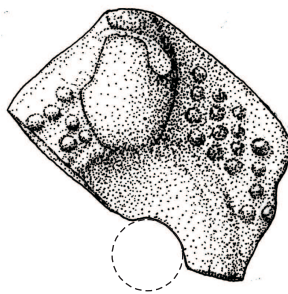

170



173



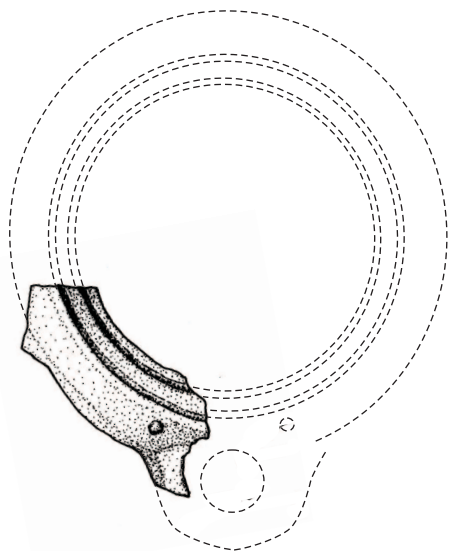

174

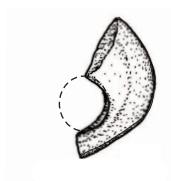

0

176

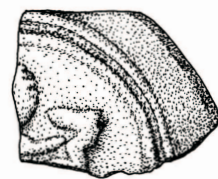

181

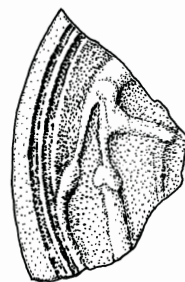

182



175



178

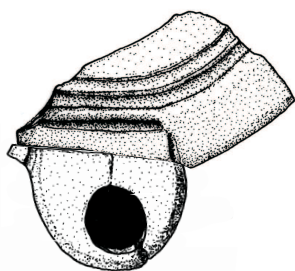

177



179



183



180



184



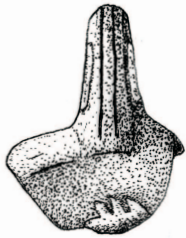

185



189

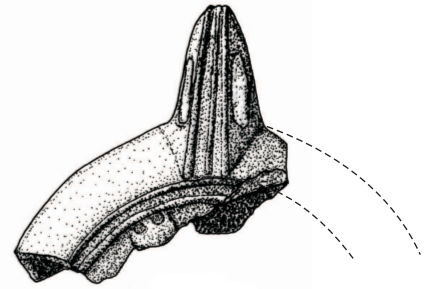

193



186

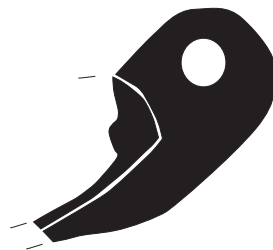

190



PF00/?/[6542] - 194



187

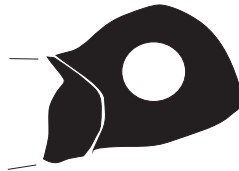

191

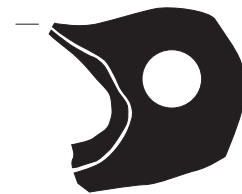

195

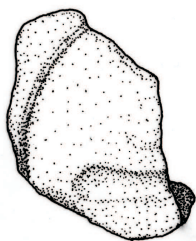

188

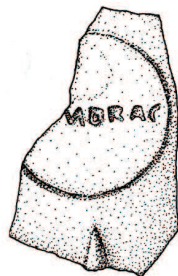

192

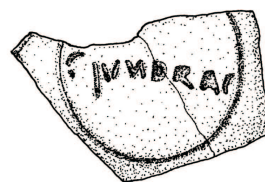

196



197



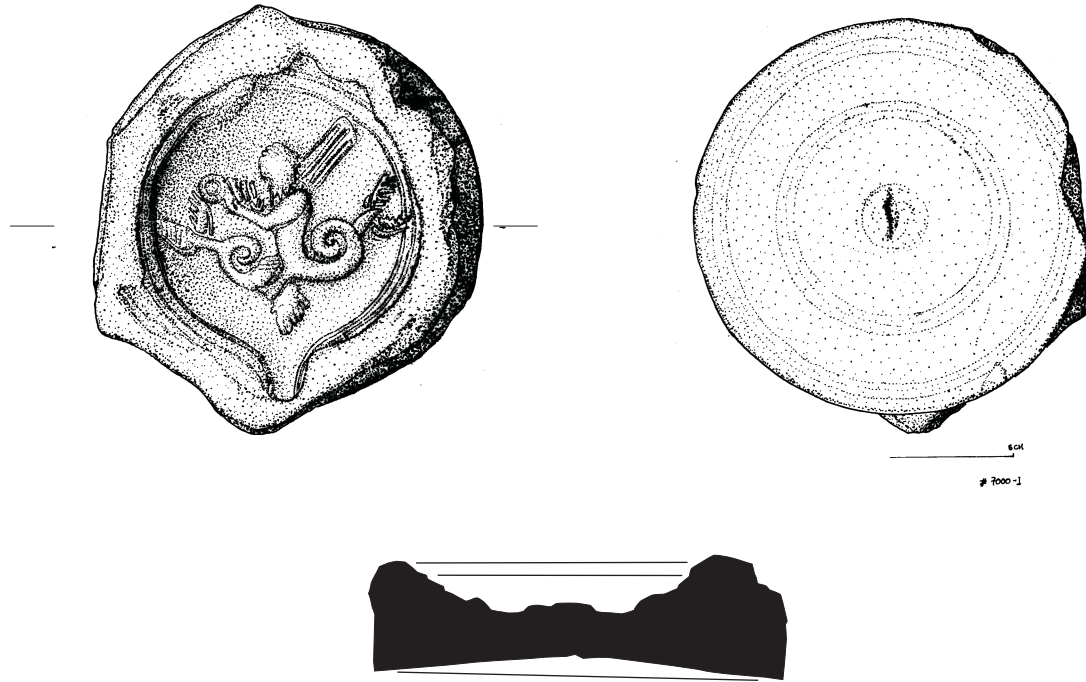

198



199



200

